

# ワイパーブレードをインストール手順 WIPER BLADE INSTALLATION INSTRUCTIONS

**LYNX**<sup>®</sup>  
SPARE PARTS *avto*

## HOOK

1

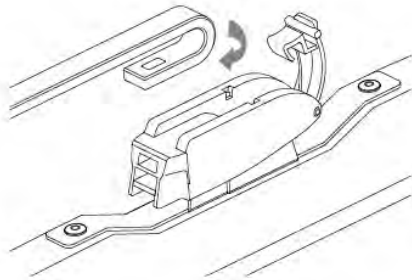

2

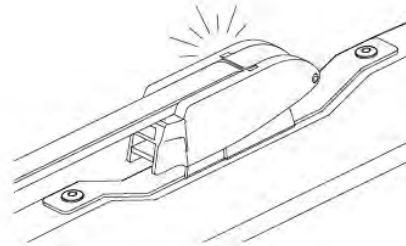

## SIDE PIN

1

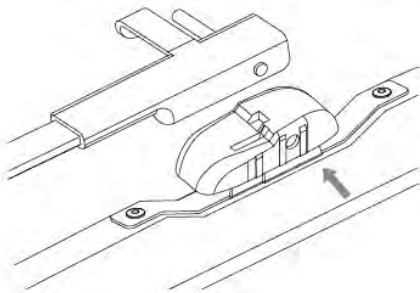

2

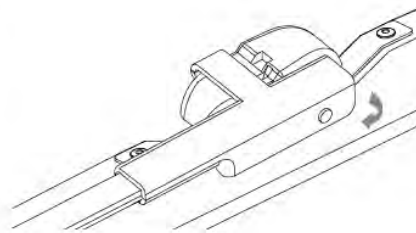

## PUSH BUTTON 16 mm

1

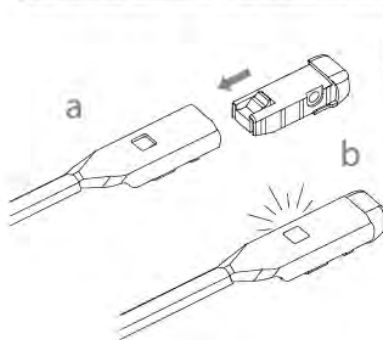

2

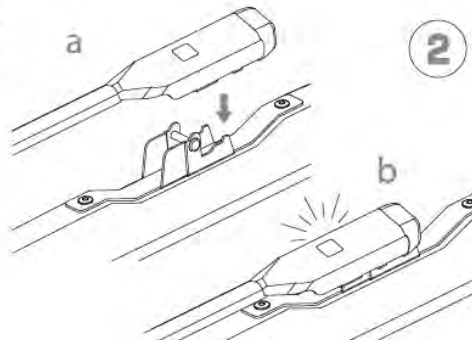

# ワイパーブレードをインストール手順 WIPER BLADE INSTALLATION INSTRUCTIONS

**LYNX**<sup>®</sup>  
SPARE PARTS *avto*

## PUSH BUTTON 19 mm

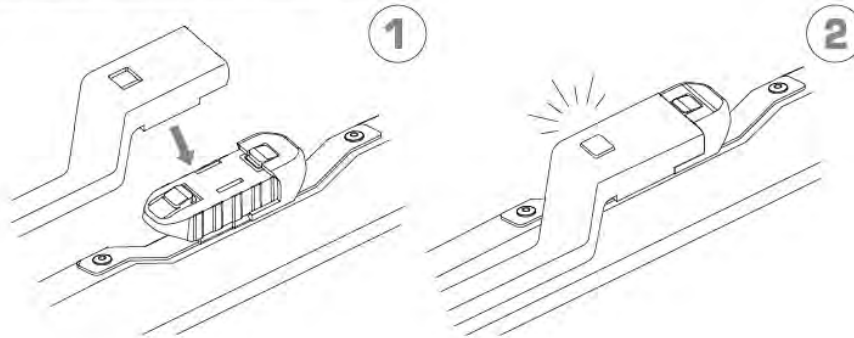

## BAYONET

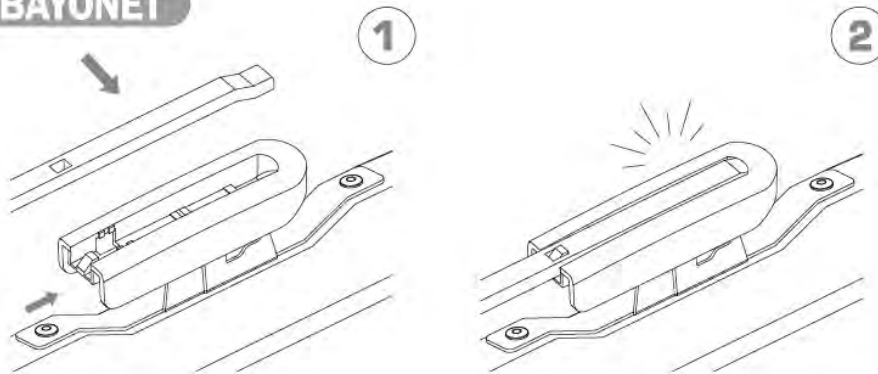

## PINCH TAB

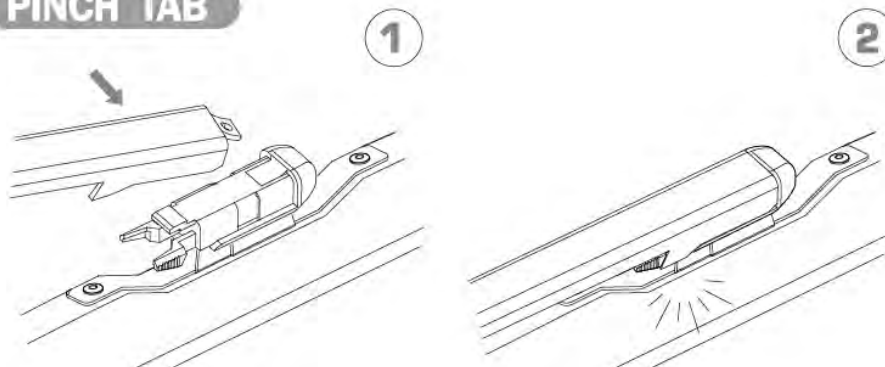

# ワイパーブレードをインストール手順 WIPER BLADE INSTALLATION INSTRUCTIONS

**LYNX**<sup>®</sup>  
SPARE PARTS *avto*

